

front

PHILIPS

Cavalal

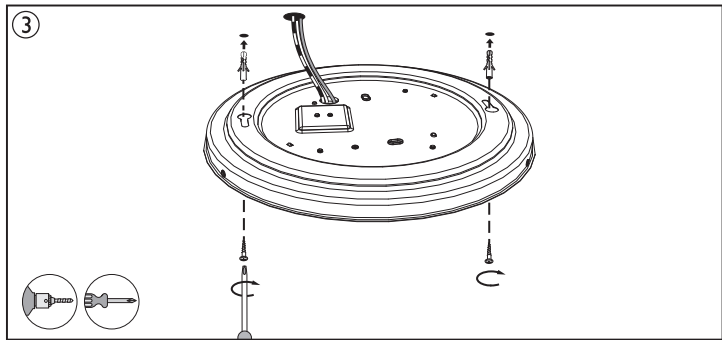
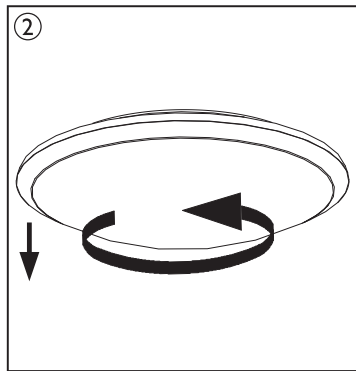
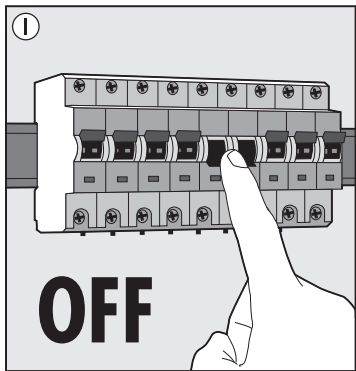
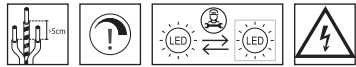
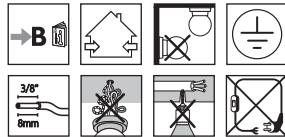

back

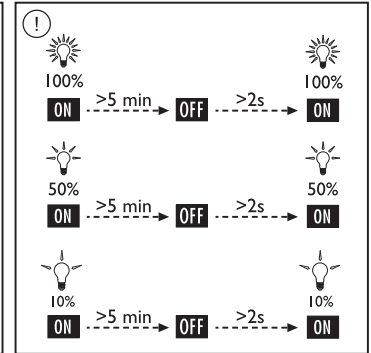
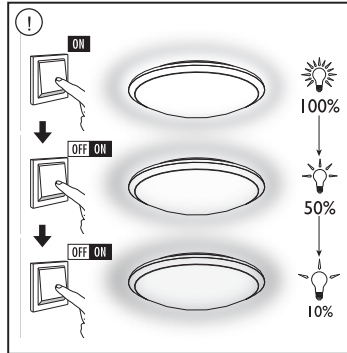
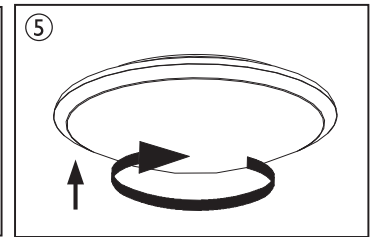
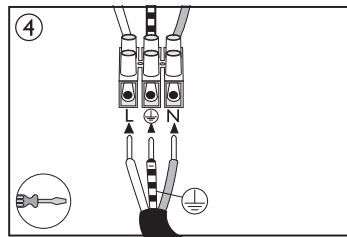

F 3280931P0 3280931P3

Philips and the Philips shield emblem are registered trademarks of Koninklijke Philips N.V.

Signify
I.B.R.S. / C.C.R.I. Numéro 10461
5600 VB Eindhoven, the Netherlands
www.philips.com/lighting

Signify Commercial UK Limited
Unit 3, Guildford Business Park,
Guildford, Surrey, GU2 8XG, UK

© 2021 Signify Holding
@signify



3241 658 21491
Last update: 12/04/21

size: 105mmx148mm